

BY	CHK	REVISION RECORD MODIFICATIONS	DATE	REV.
ALLEN		RELEASE TO PRODUCTION	2008,7,28	1.0

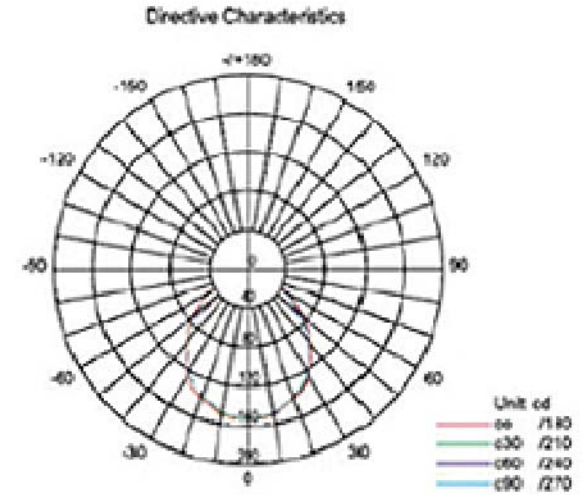

AVERAGE BEAM ANGLE(50%): 150 DEG

Relative Intensity vs. Wavelength

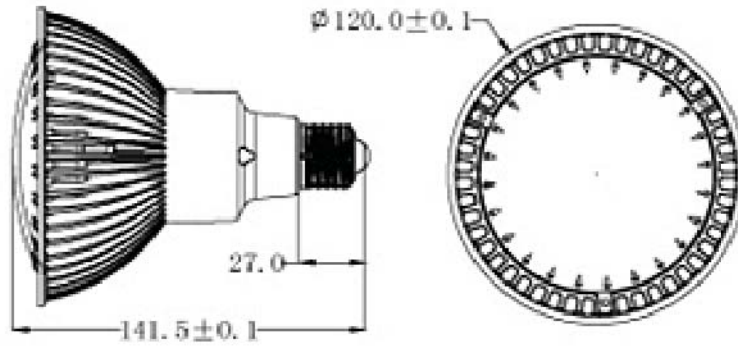
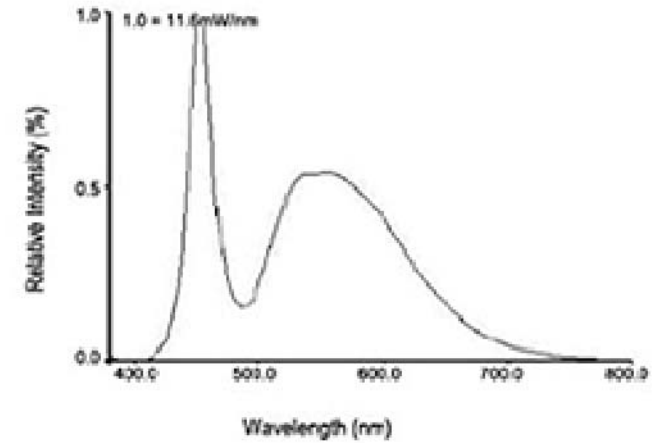

APPRO	CHECK	DRAWN	PART NO.		
			ITEM NO.		
			DRAW NO.		
			UNIT	SCALE	no
			TOLER	NO.	

DESCRIPTION

